

# FLAME STRAIGHTENING MESSER CUTTING SYSTEMS



# FLAME STRAIGHTENING

## FLAME STRAIGHTENING – THE OPTIMAL PROCESS TECHNOLOGY TO ELIMINATE WORKPIECE DISTORTION

### FLAME STRAIGHTENING:

Flame straightening is a quick and gentle way to eliminate the transverse-longitudinal shrinkage and angular distortion caused by welding.

Flame straightening is a proven production method in welding companies. The procedure is easy to use. However, the prerequisite is a good qualification of the employees.

### HEATING EFFECT DURING FLAME STRAIGHTENING

1. Local sharply limited heating  
Heating should be fast, heat accumulation must be achieved.

The temperature level depends on the material. The material must be heated up to the plastic range.

Steels 550 - 700 °C (dark red heat)  
Light metals 350 - 400 °C (wood chip sample)

2. Compression of the heated zone due to impeded thermal expansion.  
It is important to have an optimal stretching handicap. The cold environment is the most natural stretch disability. Heating for too long (wrong choice of torch; wrong fuel gas) worsen the expansion hindrance. If the impediment of thermal expansion by the cold environment is not sufficient, mechanical aids are useful. Auxiliary should not clamp, but only hold.

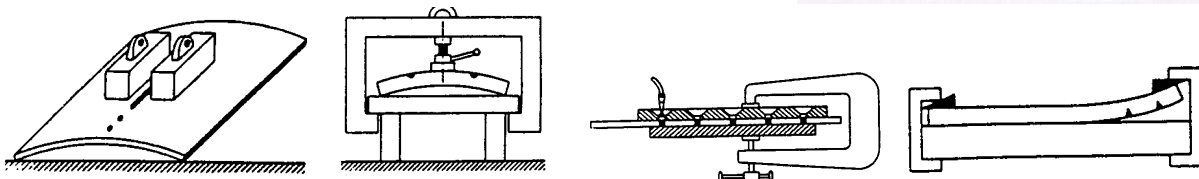
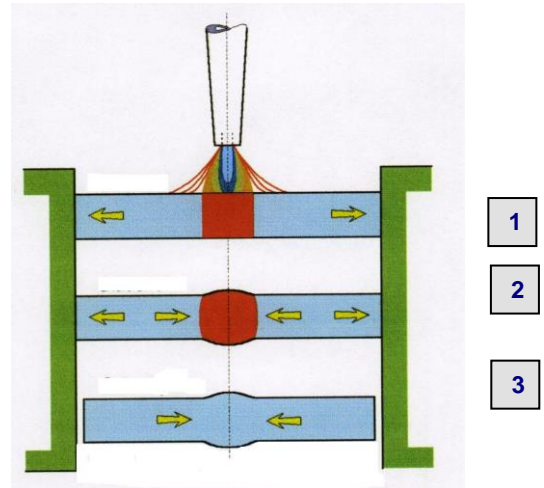

**As a result, compressive stresses build up. Plastic deformation occurs.**

3. Shrinking, shortening after cooling  
The result of flame straightening is only visible when the material has cooled down to room temperature. Normally the cooling takes place in air, but in some cases the cooling speed is increased by cooling with water. This is useful before the next heat profile is set.

# FLAME STRAIGHTENING

## FLAME STRAIGHTENING – THE OPTIMAL PROCESS TECHNOLOGY TO ELIMINATE WORKPIECE DISTORTION

### PRACTICAL EXECUTION

Depending on the part to be straightened, the heat is introduced in different heat figures.

### HEATING POINT

e.g. straightening of thin sheets or tubes

The heat point should be kept as small as possible. Straighten from the clamping to the middle of the sheet metal field.

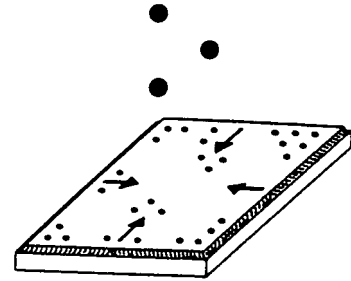

### HEAT OVAL

e.g. pipe straightening

The heat oval is heated through and arranged in the longitudinal direction of the pipe axis.

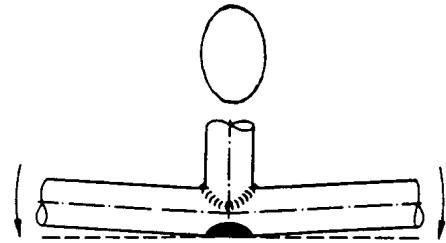

### HEAT LINE - HEAT POINTS

e.g. straighten a one-sided weld

The plastic area must not extend into the sheet depth by more than one third. The row of points bends more weakly.

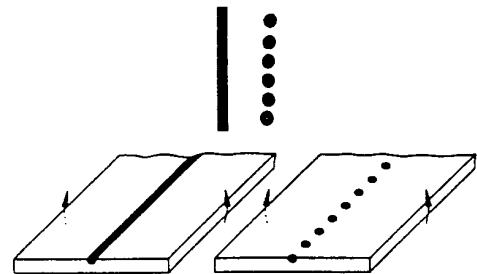

### HEAT WEDGE

e.g. straighten profiles

The heat wedge is long and narrow. It is evenly heated to the target temperature from the tip to the base.

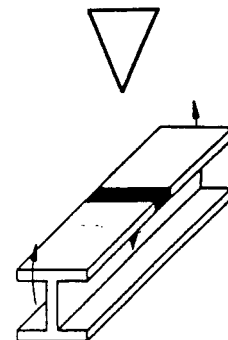

Depending on the shape of the component, a combination of these types of heating makes sense.

Version: 03/2020

# FLAME STRAIGHTENING

## FLAME STRAIGHTENING – THE OPTIMAL PROCESS TECHNOLOGY TO ELIMINATE WORKPIECE DISTORTION

### DEVICE SELECTION

The flame straightening torch is selected according to application and workpiece thickness.

### ONE-FLAME TORCH OF A NORMAL WELDING EQUIPMENT

It is the most common torch for straightening with heat spots, lines, wedges or oval-shaped.

### MULTI-FLAME TORCH

It is used for straightening with thermal screeds, wedges and ovals on workpieces from about 20 mm wall thickness.

### SPECIAL TORCH

It is designed in form and performance for the respective flame straightening task and is used, for example, for straightening large pipes or thick-walled workpieces. (F 28 A)

### SWITCHABLE FLAME TORCHES

It is used to eliminate angular distortion, to straighten walls and decks in shipbuilding and steel structures. Switchable 2-3 or 3-5 flame torches are used.

### TORCH SELECTION

The size of the flame straightening torch is determined by the type of material and the sheet thickness.

### EXAMPLE UNALLOYED AND LOW-ALLOY STEELS

For sheets up to 3 mm the torch size is selected in the same way as for welding.  
For plate thicknesses > 3 mm, the plate thickness S must be multiplied by 2 to 2.5.

e. g.:  $S = 10 \Rightarrow 10\text{mm} \times 2,5 = 25\text{mm}$  Select a size 8 torch 20 - 30 mm.

### For other materials, proceed as follows

- High-alloy steels: like unalloyed and low-alloy steels, but one size smaller
- Aluminium: like unalloyed and low-alloy steels, but one size larger
- Copper: like unalloyed and low-alloy steels, but one to two sizes larger

### ACETYLENE SUPPLY

Example:

Heating insert Type Z-A 5 for short-term operation: Consumption: 0,63 up to 0,83 m<sup>3</sup>/h = 1 Acetylene cylinder

Heating insert Type Z-A 8 for short-term operation: Consumption: 2,14 up to 2,84 m<sup>3</sup>/h = 3 Acetylene cylinders

# FLAME STRAIGHTENING

## FLAME STRAIGHTENING – THE OPTIMAL PROCESS TECHNOLOGY TO ELIMINATE WORKPIECE DISTORTION

### BASICS OF OXYFUEL TECHNOLOGY WELDING INSERT

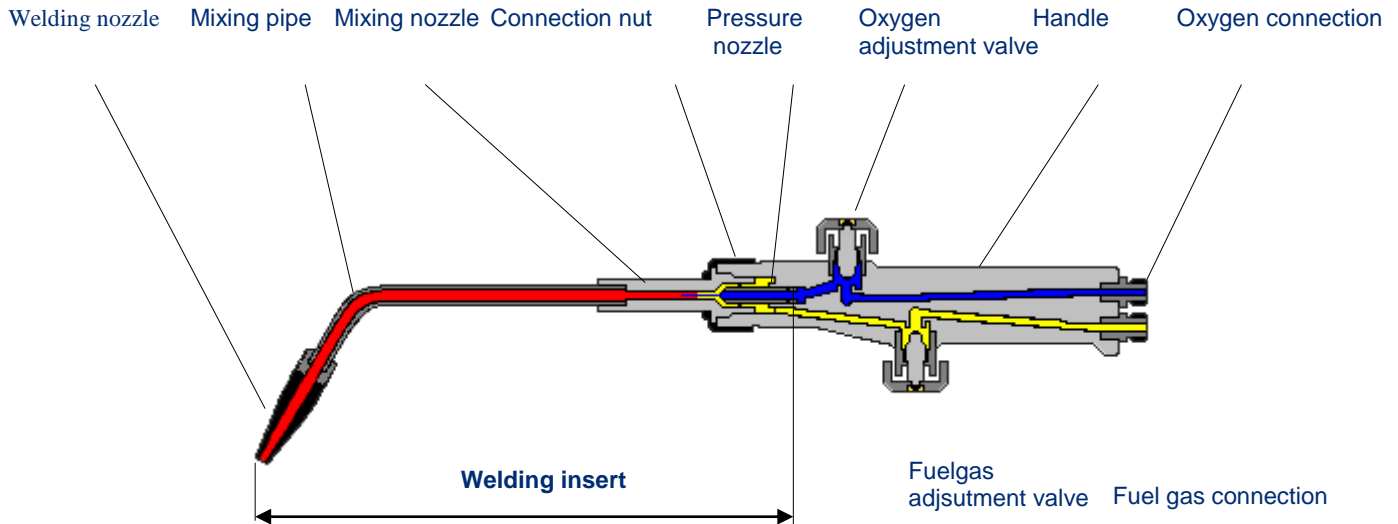

Welding insert		Oxygen	Acetylene	Manuf.- Sign	Welding insert marking			Adjustmentvalve			
Sz. No.	Welding area [mm]	Pressure [bar]	Consumption [l/h]		Consumption [l/min]	Fuelgas	Mixing - system	O2 Pressure	Insert Sz.	Color-Code O2 Fuelgas	
0	0,2 – 0,5	2,5	40 ± 5	40 ± 5		A (Acetylen)		2,5 bar	0	blue (USA green)	red
1	0,5 – 1		80 ± 10	80 ± 10					1		
2	1 – 2		160 ± 15	160 ± 15					2		
3	2 – 4		315 ± 30	315 ± 30					3		
4	4 – 6		500 ± 50	500 ± 50					4		
5	6 – 9		800 ± 80	800 ± 80					5		
6	9 – 14		1250 ± 125	1250 ± 125					6		
7	14 – 20		1800 ± 180	1800 ± 180					7		
8	20 – 30		2500 ± 250	2500 ± 250					8		

### PRACTICER'S TIP

- Calculation formula: Torch size 2 – 4

$$Q = \frac{2 + 4}{2} \cdot 100 = 300 \text{ l/h}$$

## PRODUCTS FOR FLAME STRAIGHTENING CYLINDER-PRESSURE-REGULATOR U 13 F



Cylinder pressure regulator U 13 F

### U 13 F

#### Characteristics:

- Constant working pressure through large membrane area, even with varying cylinder pressures, exact adjustments
- Safety: protected against burning out by special arrangement and quality of the seal and membrane materials
- Optimum flow characteristics and large housing surface hinder freezing
- Resistant to fluctuations through indirectly impinged membrane. Gas flow is not fed through the membrane chamber
- Resistance to burning out confirmed by BAM test
- Trade body certification 1 BG 65

#### Connections

- At the inlet a cylinder valve connection for the type of gas and at the outlet removable hose connections according to the applicable national standards

#### Safety valve

- Blows off upwards with connection for exhaust gas removal line

#### Characteristic

L10 = 6

# FLAME STRAIGHTENING

## PRODUCTS FOR FLAME STRAIGHTENING CYLINDER-PRESSURE-REGULATOR U 13 F

### Gas flow

Inlet pressure	Flow rate (m <sup>3</sup> /h) Oxygen <sup>1)</sup> With outlet pressure [bar]			
	5	10	15	20
50	200	200	200	200
30	150	150	150	150
20	100	100	100	-
15	80	80	-	-

Description	Back-Pressure	Art. No.	Cat. No.
Cylinder pressure regulator U 13 F For oxygen inlet pressure 200 Bar	10 bar	509.99850	004
Cylinder pressure regulator U 13 F For oxygen inlet pressure 200 Bar	20 bar	509.99900	004
Cylinder pressure regulator U 13 F For oxygen inlet pressure 300 Bar	10 bar	717.06901	004
Cylinder pressure regulator U 13 F For oxygen inlet pressure 300 Bar	20 bar	717.06902	004

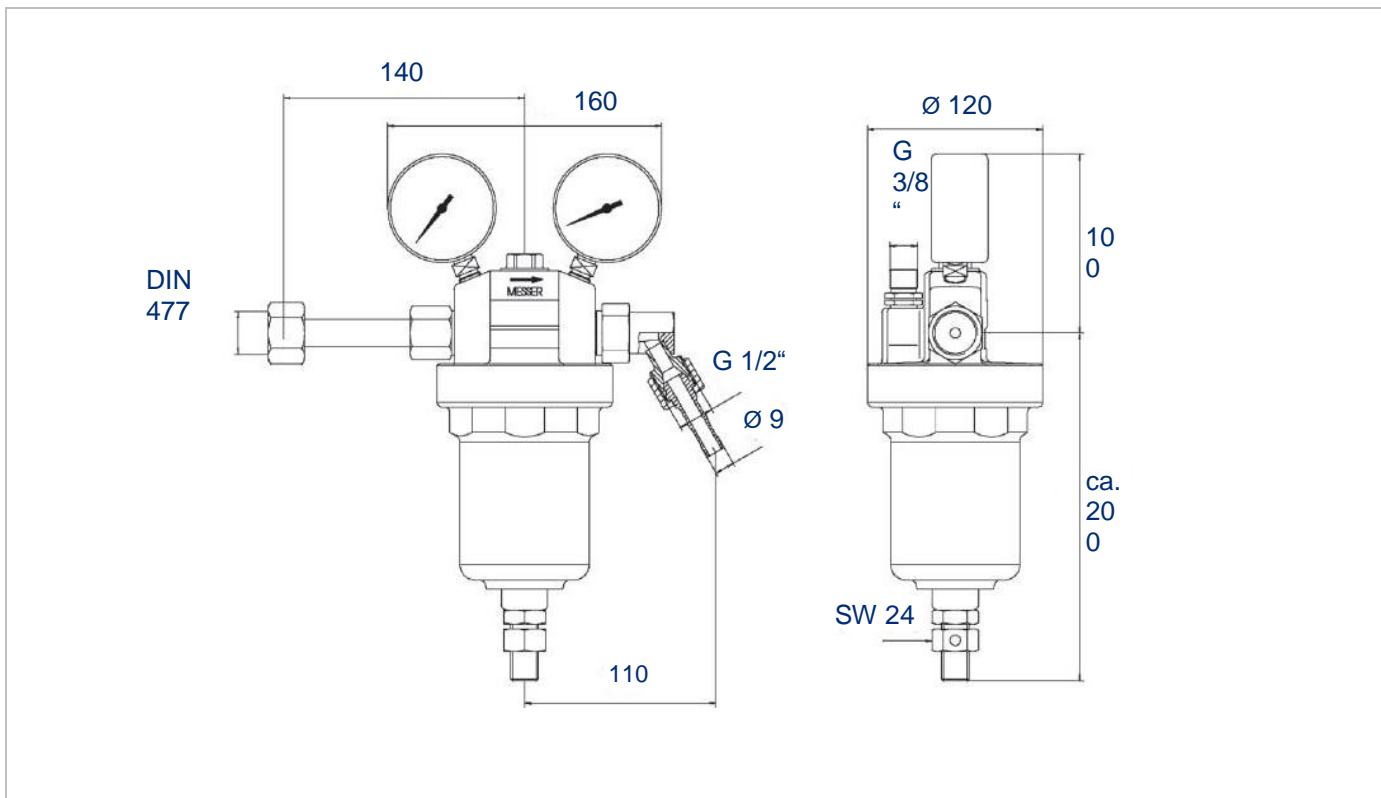

Version: 03/2020

## PRODUCTS FOR FLAME STRAIGHTENING PRESSURE CONTROL PANEL BU 13AC



Pressure Control Panel BU13AC

### GASSUPPLY

Due to the high heat output of flame straightening torches, an appropriately dimensioned gas supply is of great importance for safe working and optimum results.

A fuel gas cylinder is no longer sufficient from a torch size of only size 6. In this case either a second fuel gas cylinder, which is connected by means of a multiple distributor, or a cylinder bundle is required.

### Pressure Control Panel BU13AC

Characteristics:

- Acetylene-pressure control panels for high flow rates
- Designed for easy installation
- Single-stage systems, modular design (to be extended to 1x2, 1x3, 2x1, 2x2, 2x3 etc. cylinders / bundles)
- Pressure regulator with high control accuracy
- Pressure control panels comply with DIN-EN-ISO 14114 and DIN-EN-ISO 15615
- With all type-tested safety devices, e.g.:
  - quick-acting shut-off valve (manual)
  - Flashback arrestor
  - optionally: over-pressure valve
  - optionally: automatic quick-acting shut-off device

Connections:

- Inlet: G3/4"-LH male
- Outlet flashback arrestor: G 3/4" male
- Outlet over-pressure valve: welding stub 14x2

Safety valve

- Blows off upwards with connection for exhaust gas removal line

Characteristic

L10 = 6

### ATTENTION:

- Acetylene withdrawal systems may need to be certified before commissioning. Always refer to the local rules and regulations regarding such certifications.



# FLAME STRAIGHTENING

## PRODUCTS FOR FLAME STRAIGHTENING PRESSURE CONTROL PANEL BU 13 AC

### Flow rates BU13AC

Inlet pressure P <sub>1</sub> [bar]	Outlet pressure P <sub>2</sub> [bar]						
	0,5	0,8	1,0	1,2	1,5	2,0	2,5
18	8 m <sup>3</sup> /h	18 m <sup>3</sup> /h	25 m <sup>3</sup> /h	31 m <sup>3</sup> /h	42 m <sup>3</sup> /h	60 m <sup>3</sup> /h	61 m <sup>3</sup> /h
10	8 m <sup>3</sup> /h	17 m <sup>3</sup> /h	23 m <sup>3</sup> /h	29 m <sup>3</sup> /h	39 m <sup>3</sup> /h	58 m <sup>3</sup> /h	61 m <sup>3</sup> /h
6	8 m <sup>3</sup> /h	17 m <sup>3</sup> /h	23 m <sup>3</sup> /h	29 m <sup>3</sup> /h	39 m <sup>3</sup> /h	45 m <sup>3</sup> /h	45 m <sup>3</sup> /h
4	8 m <sup>3</sup> /h	18 m <sup>3</sup> /h	23 m <sup>3</sup> /h	28 m <sup>3</sup> /h	29 m <sup>3</sup> /h	28 m <sup>3</sup> /h	29 m <sup>3</sup> /h
2	7 m <sup>3</sup> /h	12 m <sup>3</sup> /h	13 m <sup>3</sup> /h	13 m <sup>3</sup> /h	13 m <sup>3</sup> /h	13 m <sup>3</sup> /h	--

### Flow rates BU13AC:

The withdrawal rate should not exceed approx. 0.5 Nm<sup>3</sup>/h per cylinder in permanent operation, so no solvent from the cylinder will enter the withdrawal system. However, the flow rate may be increased to approx. 1m<sup>3</sup>/h for brief peak loads.

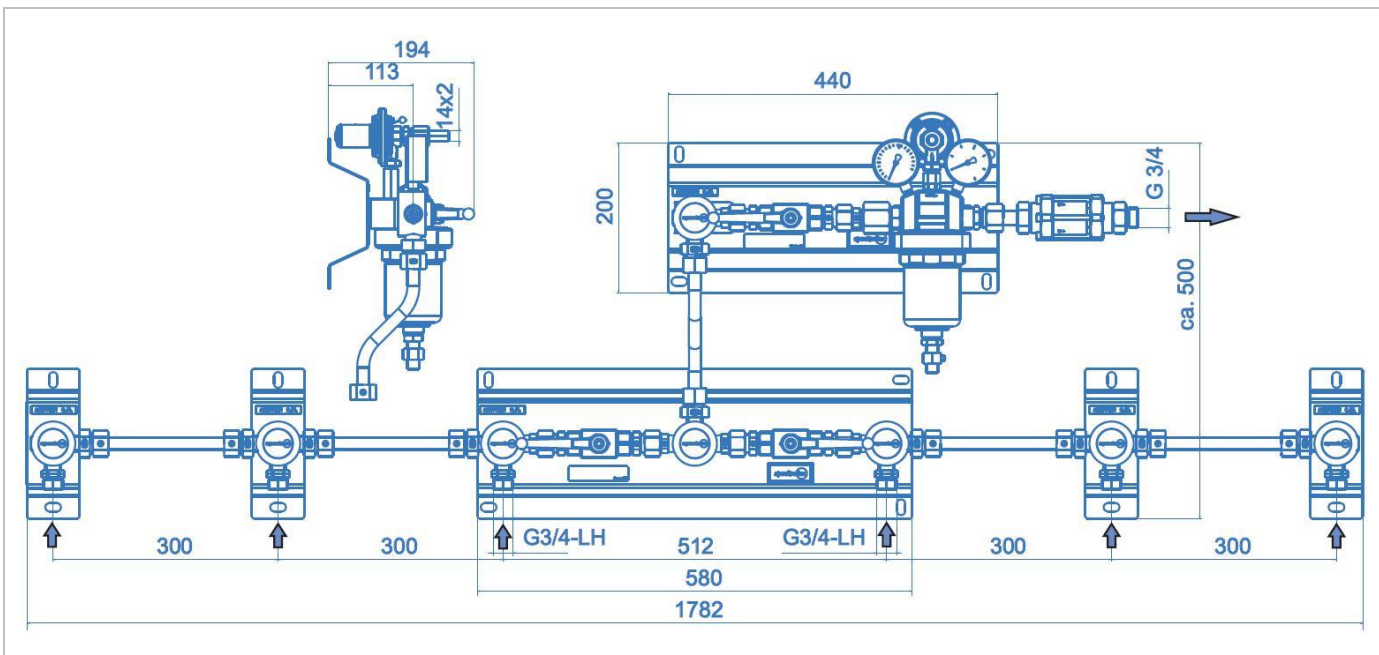

# FLAME STRAIGHTENING

## PRODUCTS FOR FLAME STRAIGHTENING CYLINDER COUPLINGS & PRESSURE REGULATORS

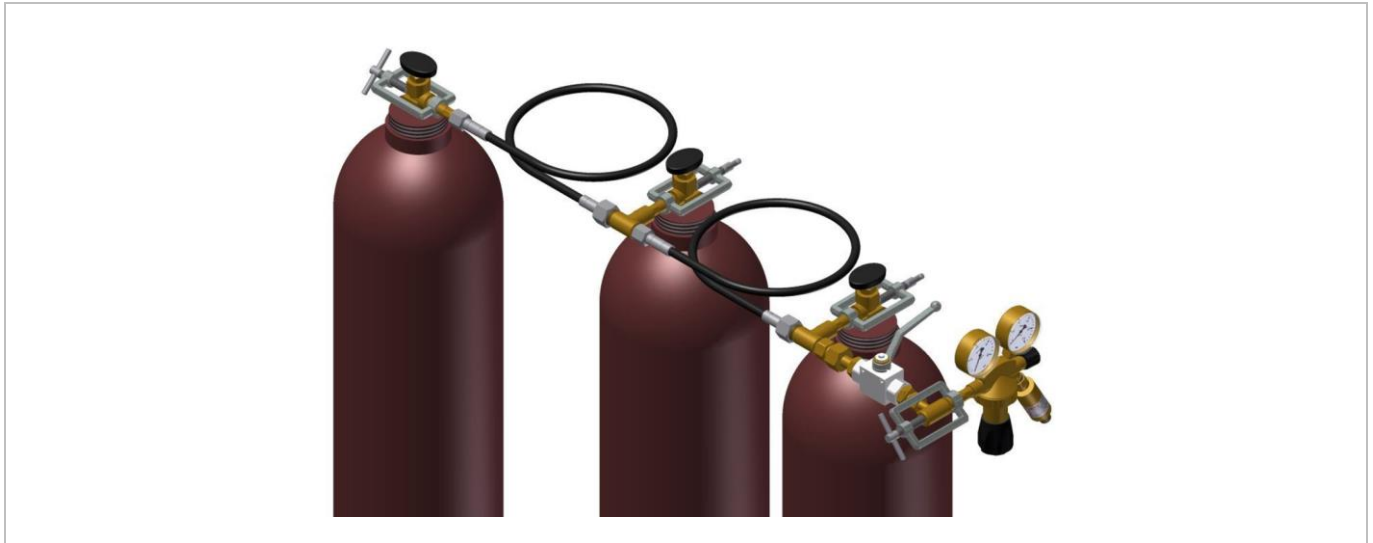

Cylinder couplings

Cylinder coupling for connecting 2 or 3 single acetylene cylinders (up to 6 cylinders possible on request), consisting of:

- Cylinder connection clamp
- HP- Connection hose
- Safety device
- Block ball valve as high-pressure shut-off valve
- Connection piece for cylinder pressure regulator

Particularly suitable for the operation of heat torches with medium capacity, if a single cylinder does not allow sufficient acetylene withdrawal and a cylinder bundle is not available.

### Cylinder connection to connect single cylinders

### CYLINDER COUPLING

Type	Type of Gas	Qty	Connection Type	Art.-No.
FK-A2 RSV	Acetylene	2	Clamp	716.54846
FK-A3 RSV	Acetylene	3	Clamp	716.54847



Safety device:  
Hand-operated quick-acting shut-off device

Acetylene supply	Withdrawal [m³/h]		
	Short-term < 15 min	normal = 8 H	permanent > 8 h
Single cylinder	1	0,5	0,35
Bundle 6 cylinders	6	3	2
Bundle 12 cylinders	18	8	2,5

Example:

Heating insert Type FB-A 5 in normal operation:  
Heating insert Type FB-A 8 in normal operation:

Consumption: 0,63 up to 0,83 m³/h = 2 Acetylene cylinders  
Consumption: 2,14 up to 2,84 m³/h = 3 Acetylene cylinders

# FLAME STRAIGHTENING

## PRODUCTS FOR FLAME STRAIGHTENING CYLINDER COUPLINGS & PRESSURE REGULATORS

### OXYGEN

Single stage with inlet pressure 200 bar



<i>Back-pressure max.</i>	<i>Cylinder connection</i>	<i>Hose connection</i>	<i>Art.-No.</i>	<i>Cat.-No.</i>
10 bar	G 3/4"	G 1/4", DN 6	716.20100	025
20 bar	G 3/4"	G 1/4", DN 6	716.20101	025

With polymer spring bonnet for outlet pressures up to 20 bar

Union nut G 1/4"			700.50030	008
Hose nipple DN 6			700.50050	008

### ACETYLENE

Single stage with inlet pressure 25 bar



<i>Back-pressure max.</i>	<i>Cylinder connection</i>	<i>Hose connection</i>	<i>Art.-No.</i>	<i>Cat.-No.</i>
1,5 bar	Clamp	G 3/8" LH, DN 9	716.20107	025

Union nut G 3/8" LH			700.50040	008
Hose nipple DN 9			471.40090	008

### PROPANE

Single stage with inlet pressure 10 bar



<i>Back-pressure max.</i>	<i>Cylinder connection</i>	<i>Hose connection</i>	<i>Art.-No.</i>	<i>Cat.-No.</i>
2,5 bar	W 21,80 x 1/14" LH	G 3/8" LH, DN 9	716.20108	026

Union nut G 3/8" LH			700.50040	008
Hose nipple DN 9			471.40090	008

### OXYGEN

Single stage with inlet pressure 300 bar



<i>Back-pressure max.</i>	<i>Cylinder connection</i>	<i>Hose connection</i>	<i>Art.-No.</i>	<i>Cat.-No.</i>
10 bar	W30x2 - Ø 17.3/18.3	G 1/4", DN 6	717.06716	026
20 bar	W30x2 - Ø 17.3/18.3	G 1/4", DN 6	717.06717	026

Union nut G 1/4"			700.50030	008
Hose nipple DN 6			700.50050	008

# FLAME STRAIGHTENING

## PRODUCTS FOR FLAME STRAIGHTENING SAFETY DEVICES

For the protection of cylinder regulators and tapping points

**DG 91 N**

Type of gas	Connection	Operating pressure (max.)	Art.-No.	Cat.-No.
Oxygen	G 1/4" RH	25 bar	0.463.291	041
Oxygen	G 3/8" RH	25 bar	0.463.330	041
Oxygen	G 1/2" RH	25 bar	0.463.331	041
Fuel gas	G 3/8" LH	5,0 bar	0.463.290	041
Fuel gas	G 1/2" LH	5,0 bar	0.463.329	041

Safety units: FA, NV, TV

Fuel gas operating pressure (max.): Acetylene 1,5 bar, Hydrogen 4,0 bar



For the protection of cylinder regulators and tapping points

**DEMAM 5**

Type of gas	Connection	Operating pressure (max.)	Art.-No.	Cat.-No.
Oxygen	G 1" RH	25 bar	0.463.810	041
Fuel gas	G 1" RH	5,0 bar	0.463.809	041

Safety units: FA, NV, TV  
for high gas flow

Fuel gas operating pressure (max.): Acetylene 1,5 bar, Hydrogen 4,0 bar

or connection fittings see next page)



For the protection of cylinder regulators and tapping points

**SIMAX 3**

Type of gas	Connection	Operating pressure (max.)	Art.-No.	Cat.-No.
Oxygen	G 1" RH	25 bar	0.463.814	041
Fuel gas	G 1" RH	5,0 bar	0.463.813	041

Safety units: FA, NV, TV

Fuel gas operating pressure (max.): Acetylene 1,5 bar, Hydrogen 4,0 bar

or connection fittings see next page)



For the protection of cylinder regulators and tapping points

**SIMAX 5**

Type of gas	Connection	Operating pressure (max.)	Art.-No.	Cat.-No.
Oxygen	G 1" RH	25 bar	0.463.816	041
Fuel gas	G 1" RH	5,0 bar	0.463.815	041

Safety units: FA, NV, TV

Fuel gas operating pressure (max.): Acetylene 1,5 bar, Hydrogen 4,0 bar

or connection fittings see next page)



# FLAME STRAIGHTENING

## PRODUCTS FOR FLAME STRAIGHTENING SAFETY DEVICES

### DEMAX / SIMAX

Inlet connection nipple for non-flammable gases

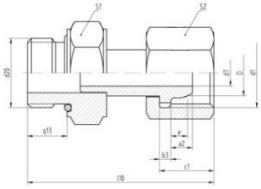

Connection on DEMAX / SIMAX	Line connection	Art.-No.	Cat.-No.
G 1"	G 3/8" RH	0.463.410	041
G 1"	G 1/2" RH	0.463.408	041
G 1"	G 3/4" RH	0.463.380	041
G 1"	G 1" RH	0.463.339	041

Including O-ring seal between connection nipple and safety unit

### DEMAX / SIMAX

Inlet connection nipple for flammable gases

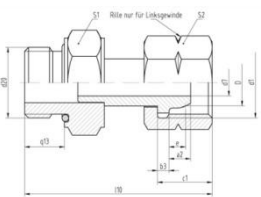

Connection on DEMAX / SIMAX	Line connection	Art.-No.	Cat.-No.
G 1"	G 3/8" LH	0.463.411	041
G 1"	G 1/2" LH	0.463.409	041
G 1"	G 3/4" LH	716.52536	041
G 1"	G 1" LH	0.463.340	041

Including O-ring seal between connection nipple and safety unit

### DEMAX / SIMAX

Outlet connection nipple for non-flammable gases

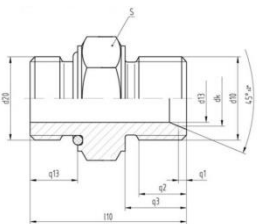

Connection on DEMAX / SIMAX	Line connection	Art.-No.	Cat.-No.
G 1"	G 3/8" RH	0.463.414	041
G 1"	G 1/2" RH	0.463.412	041
G 1"	G 3/4" RH	0.463.341	041
G 1"	G 1" RH	0.463.343	041

Including O-ring seal between connection nipple and safety unit

### DEMAX / SIMAX

Outlet connection nipple for non-flammable gases

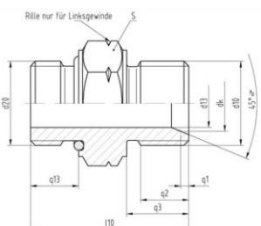

Connection on DEMAX / SIMAX	Line connection	Art.-No.	Cat.-No.
G 1"	G 3/8" LH	0.463.415	041
G 1"	G 1/2" LH	0.463.413	041
G 1"	G 3/4" LH	0.463.342	041
G 1"	G 1" LH	0.463.344	041

Including O-ring seal between connection nipple and safety unit

# FLAME STRAIGHTENING

## PRODUCTS FOR FLAME STRAIGHTENING STAR

Sturdy handle made of aluminum, particularly robust, maintenance free and easy to repair

### HANDLES

Type	Description	Connections	Art.-No.	Cat.-No.
STAR 2020	Valve arrangement lateral	Oxygen: G 1/4" Fuel gas: G 3/8" LH	716.06820	024
STAR 1010	Valves V-positioned	Oxygen: G 1/4" Fuel gas: G 3/8" LH	716.07725	024



Length: approx. 230 mm, shaft diameter: 20 mm, weight: approx. 550 g

The ergonomic, especially sturdy design of our STAR handles allows easy handling, fatigue-free working and high operation comfort. Self-tensioning radial seals enable fast and safe sealing; the union nut can easily be tightened by hand.

For standard applications, nozzles replaceable

### WELDING INSERT 210-A

Size	O <sub>2</sub> -Consumption	Welding range	Art.-No. insert cpl.	Art.-No. Welding nozzle	Cat.-No.
1	Approx. 80 l/h	0,5 - 1,0 mm	716.01621	242.34110	024/007
2	Approx. 160 l/h	1,0 - 2,0 mm	716.01622	242.34210	024/007
3	Approx. 315 l/h	2,0 - 4,0 mm	716.01623	242.34310	024/007
4	Approx. 500 l/h	4,0 - 6,0 mm	716.01624	242.34410	024/007
5	Approx. 800 l/h	6,0 - 9,0 mm	716.01625	242.34510	024/007
6	Approx. 1.250 l/h	9,0 - 14,0 mm	716.01626	242.34610	024/007
7	Approx. 1.800 l/h	14,0 - 20,0 mm	716.01627	242.34710	024/007
8	Approx. 2.500 l/h	20,0 - 30,0 mm	716.01628	242.34810	024/007



Tips for welding, brazing and heating, with hammered welding and heating nozzles, fuel gas acetylene

Central flame outlet, nozzles replaceable

### BRAZING- AND WELDING INSERT Z-A

Size	O <sub>2</sub> -Consumption	Overall length Approx.	Art.-No. insert cpl.	Art.-No. Welding nozzle	Cat.-No.
9	max. 4,7 m <sup>3</sup> /h	695 mm	716.00863	716.00170	004
9 ES	max. 4,7 m <sup>3</sup> /h	950 mm	716.07296	716.00170	024
10	max. 5,8 m <sup>3</sup> /h	695 mm	716.00865	716.00171	004
10 ES	max. 5,8 m <sup>3</sup> /h	1155 mm	716.07297	716.00171	024



Tips for brazing and spot heating with acetylene  
ES = Stainless steel mixing tube

Central flame outlet, protection sleeve replaceable

### INSERT KONSTANTHERM

Size	O <sub>2</sub> -Consumption	Overall length Approx.	Art.-No. insert cpl.	Art.-No. Protection sleeve	Cat.-No.
6	1,25 m <sup>3</sup> /h	375 mm	242.56600	677.51963	004
8	2,50 m <sup>3</sup> /h	445 mm	242.56800	677.51965	004



Special tips for welding and heating under high thermal load, fuel gas acetylene

# FLAME STRAIGHTENING

## PRODUCTS FOR FLAME STRAIGHTENING STAR

### BRAZING- AND WELDING INSERT FB-A

Laminar flame outlet, nozzles replaceable, particularly low noise



Size	O <sub>2</sub> -Consumption	Overall length Approx.	Art.-No. insert cpl.	Art.-No. Welding nozzle	Cat.-No.
5	max. 1,1 m <sup>3</sup> /h	310 mm	716.01915	716.00725	004
6	max. 1,9 m <sup>3</sup> /h	340 mm	716.01916	716.00726	004
7	max. 2,3 m <sup>3</sup> /h	390 mm	716.00757	716.00727	004
8	max. 3,3 m <sup>3</sup> /h	410 mm	716.00758	716.00728	004
9	max. 5,5 m <sup>3</sup> /h	675 mm	716.00759	716.00779	004
9 ES	max. 5,5 m <sup>3</sup> /h	940 mm	716.07298	716.00779	024/004
10	max. 6,1 m <sup>3</sup> /h	675 mm	716.00772	716.00780	004
10 ES	max. 6,1 m <sup>3</sup> /h	1140 mm	716.077299	716.00780	024/004

Tips for laminar brazing and heating with acetylene, noise level below 85 dB(A) up to size 8  
ES = stainless steel mixing tube

### FLAME STRAIGHTENING ATTACHMENT STAR

For flame straightening, reversible for 3/2" or 5/3" flames Fuel gas: acetylene



Description	Overall length Approx.	Size	Art.-No.	Cat.-No.
reversible for 3/2" flames	505 mm	2 - 4 mm	716.01760	004
reversible for 3/2" flames	540 mm	4 - 6 mm	716.01761	004
reversible for 5/3" flames	550 mm	2 - 4 mm	716.01762	004
reversible for 5/3" flames	550 mm	4 - 6 mm	716.01763	004

### STAR-FLAME STRAIGHTENING KIT

High-performance kit for flame straightening



Description	Inlet connections Handle: Oxygen	Inlet connections Handle: Fuelgas	Art.-No.	Cat.-No.
Kit: for fuel gas Acetylene	G 1/4" RH	G 3/8" LH	716.07662	010
Kit: for fuel gas Propane, Methane	G 1/4" RH	G 3/8" LH	716.07663	010

1 handle type STAR 2020, set of nozzle cleaners, gas igniter, aluminum case 62x43x22cm, operating instructions

#### For Acetylene:

1 Flame Straightening Attachment STAR-Z-A-3 with 3 heating nozzles size: 2-4,  
With bogie wheels

5 Heating Attachments

STAR-210-A Size: 2+3+6+7;

STAR-FB-A Size: 7

#### For Propane:

1 Flame Straightening Attachment STAR-PMY with 3 heating inserts size: 4-6,  
with bogie wheels

4 Heating Attachments

STAR-Z-PMY Size: 6+10;

STAR-F-PM Size: 8+12

Other compositions of complete sets available.

# FLAME STRAIGHTENING

## PRODUCTS FOR FLAME STRAIGHTENING STAR & SUPERTHERM

Flexible, mixing tube with brazed-on nozzle replaceable

### WELDING INSERT 410-A

Size	O <sub>2</sub> -Consumption	Welding range	Art.-No. insert cpl.	Art.-No. Welding nozzle	Cat.-No.
2	approx. 160 l/h	1,0 - 2,0 mm	716.01712	716.01752	024/007
3	approx. 315 l/h	2,0 - 4,0 mm	716.01713	716.01753	024/007
4	approx. 500 l/h	4,0 - 6,0 mm	716.01714	716.01544	024/007
5	approx. 800 l/h	6,0 - 9,0 mm	716.01715	716.01755	024/007
7	approx. 1.800 l/h	14,0 – 20,0 mm	716.54280	716.54279	039/007



#### Size 7 = special size

Pipe welding tips for welding, brazing and heating in hard to reach locations, fuel gas acetylene

Maintenance free and easy to repair

### HANDLES

Type	Description	Connections	Art.-No.	Cat.-No.
Superttherm	Valve arrangement rectangular	Oxygen: G 3/8"/DN 9  Fuel gas: G 1/2"LH/DN 11 mm	716.01818	004



Length: approx. 300 mm, shaft diameter: 22 mm, weight: approx. 915 g

The rectangular valve arrangement of the robust designed SUPERTHERM handle enables easy medium control; the monoblock valves do not require maintenance and guarantee long service life. The handle body is made of light metal with hard coating and is thus resistant against corrosion from sea water and other aggressive substances at the workplace. Inlet connections, monoblock valves and shaft connections are easy to replace.

Laminar flame outlet, nozzles replaceable, fuel gas acetylene

### SUPERTHERM F-A

Size	O <sub>2</sub> -Consumption	Overall length Approx.	Art.-No. insert cpl.	Art.-No. Welding nozzle	Cat.-No.
9	max. 4,8 m <sup>3</sup> /h	650 mm	716.02090	716.00422	004
11	max. 9,4 m <sup>3</sup> /h	650 mm	716.02091	716.00423	004



Tips for laminar heating

Central flame outlet, nozzles replaceable, fuel gas acetylene

### SUPERTHERM Z-A

Size	O <sub>2</sub> -Consumption	Overall length Approx.	Art.-No. insert cpl.	Art.-No. Welding nozzle	Cat.-No.
9	max. 4,4 m <sup>3</sup> /h	670 mm	716.02092	716.00170	004
10	max. 5,9 m <sup>3</sup> /h	670 mm	716.02093	716.00171	004



Tips for spot heating



# FLAME STRAIGHTENING

## PRODUCTS FOR FLAME STRAIGHTENING SUPERTHERM

### TYPE F-A 28

With interchangeable multi hole heating nozzle



Size	O <sub>2</sub> -Consumption [l/h]	Art.-No. insert cpl.	Art.-No. Heating nozzle	Cat.-No.
28	≤ 12.000	716.04421	716.05094	039

### TYPE FD-A

High performance torch with separated gas supply



Size	O <sub>2</sub> -Consumption [l/h]	Art.-No. insert w/o nozzle	Art.-No. Heating nozzle	Cat.-No.
20	7.900 - 14.700	716.02125	716.00967	004/039

# FLAME STRAIGHTENING

## PRODUCTS FOR FLAME STRAIGHTENING ACCESSORIES

Oxygen hoses acc. to DIN EN ISO 3821, identification color: blue

Dimensions	Marking	Torch system	Art. No.	Cat. No.
DN 6 x 5	Messer	STAR	051.01010	043
DN 8 x 3,5	Messer		0.469.033	000
DN 9 x 5,5	Messer	SUPERTHERM	051.01060	043
DN 11 x 5,5	Messer		051.01200 *	043

Sold by the meter, without fittings



Acetylene hoses acc. To DIN EN ISO 3821, identification color: red

Dimensions	Marking	Torch system	Art. No.	Cat. No.
DN 8 x 3,5	Messer	STARLET / STAR	051.00040	043
DN 11 x 5,5	--	SUPERTHERM	051.00050	043
DN 12 x 5,5	--		051.00130 *	043

Sold by the meter, without fittings



Hoses for all fuel gases acc. to DIN EN ISO 3821, identification color: orange / red

Dimensions	Marking	Torch system	Art. No.	Cat. No.
DN 6,3 x 3,5	Messer	STARLET	0.462.863	043
DN 8 x 3,5	Messer	STARLET / STAR	0.462.859	043
DN 10 x 4	Messer	SUPERTHERM	0.462.860	043

Sold by the meter, without fittings



Twin oxyfuel hoses-oxygen / fuel gas- acc. to DIN EN ISO 3821, identification colors: blue / red

Dimensions	Marking	Torch system	Art. No.	Cat. No.
DN 6,3 x 5 / DN 9 x 3,5	Oxygen blue / fuel gas red	STARLET / STAR	0.462.147	043

Sold by the meter, without fittings



# FLAME STRAIGHTENING

## PRODUCTS FOR FLAME STRAIGHTENING ACCESSORIES

Twin oxyfuel hoses-oxygen / fuel gas- acc. to DIN EN ISO 3821, identification colors: blue / red, cpl. assembled with fittings



Hose length	Oxygen G 1/4"	Fuel gas G 3/8"LH	Art. No.	Cat. No.
5 m	DN 6 x 5	DN 8 x 3,5	0.469.013	043
10 m	DN 6 x 5	DN 8 x 3,5	0.469.014	043
20 m	DN 6 x 5	DN 8 x 3,5	0.469.015	043
40 m	DN 6 x 5	DN 8 x 3,5	0.469.016	043
5 m	DN 6 x 3,5	DN 6 x 3,5	0.469.017	043
10 m	DN 6 x 3,5	DN 6 x 3,5	0.469.018	043
20 m	DN 6 x 3,5	DN 6 x 3,5	0.469.019	043
40 m	DN 6 x 3,5	DN 6 x 3,5	0.469.020	043

Hose Assembly: Requirements acc. to DIN EN 1256

The fixing of oxyfuel hoses was defined with DIN EN 1256: 2008-3 .

Quote: DIN EN 1256 Pkt. 4.2.3 „Hose Connections“:

„The hose needs to be connected with a matching hose fixing using a hose connecting nipple, to build a re-producible joint. The use of worm screw collars or other loose connections is prohibited“. This regulation obligates the user to work with adequate connections, e.g. squeezed cartridges.

Furthermore, DGUV 100-500, chapter 2.26, national accident prevention regulations, do apply:

Gas hoses must be prepared in a way, that a slipping off the hose clips is prevented, and that connections and hose fixations meet the requirements of the used gas type.

### Gas igniter



Type / description	Art. No.	Cat. No.
<b>Gas igniter</b> staple brass frame, wing nut nickel plated, with friction wheel and guard rail	052.02900	043
Spare flints 3 x 20 mm	052.02710	043



# CREATING SOLUTIONS BEYOND MACHINES

## What we stand for

### PRODUCT

Messer Cutting Systems is a global supplier of cutting edge technology for the metalworking industry.

### AUTOMATION

With over 900 employees worldwide in over 50 countries, we maintain a constant dialogue with our customers to achieve sustainable user-oriented innovation.

### DIGITAL

### SERVICES

Our portfolio embraces the themes PRODUCT, DIGITAL, SERVICES, AUTOMATION and KNOW-HOW. We will live up to our claim "creating solutions beyond machines" not just with the most modern cutting systems and solutions for oxyfuel technology.

### KNOW-HOW

Appropriate services and training, our own software applications as well as the integration of solutions from our technology partners, e. g. in the field of automation, complete the machine to give forward-looking total solutions.

Our know-how combined with our customer-oriented attitude and actions have made us the worldwide partner of choice for innovative total solutions on all aspects of cutting systems for over 120 years.

## Messer Cutting Systems India Private Limited

WNo 199/2AB2, 198/2A2A & 198/2A2B  
SNMV College Road, Malumichampatti,  
Coimbatore - 641 050,  
Tamil Nadu, India

Tel : +91 422 6725501

Mail : sales.all@messer-cutting.com

[messer-cutting.com](http://messer-cutting.com)

